

ODEON LIGHT INSTALLATION INSTRUCTION

Item No.: 2749/5C

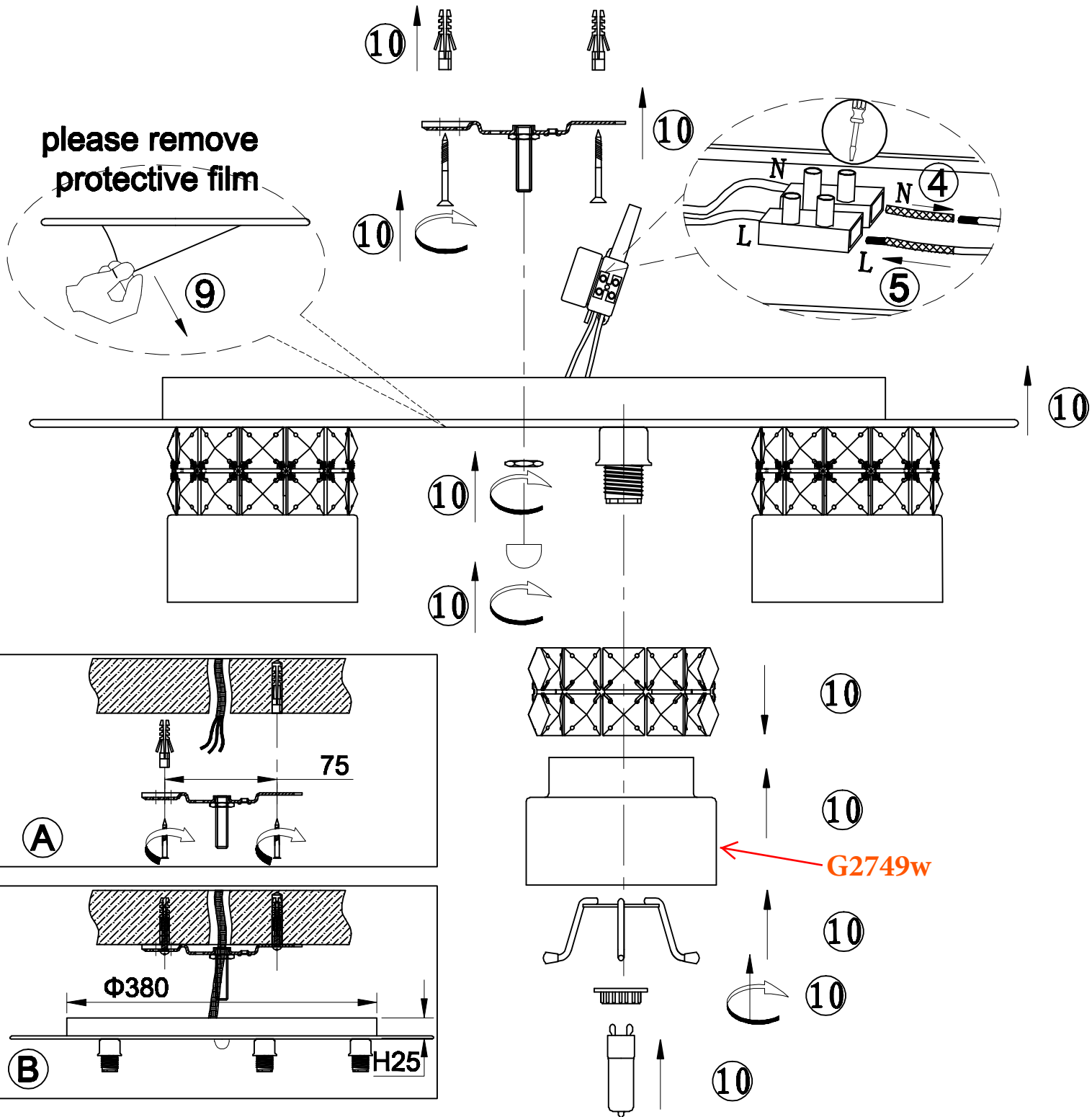

FEATURE

●220-240V~50Hz

●Lamp Type: G9 5× MAX 42W

The lamp can be only indoor used

If in doubt, consult a qualified electrician or contact your retail outlet. Ensure that you always install the fitting to the relevant regulations. Certain regulations indicate that lighting fittings should be installed by a qualified electrician.