

# INSTALLATION INSTRUCTION ODEON LIGHT ART . 2726/3C

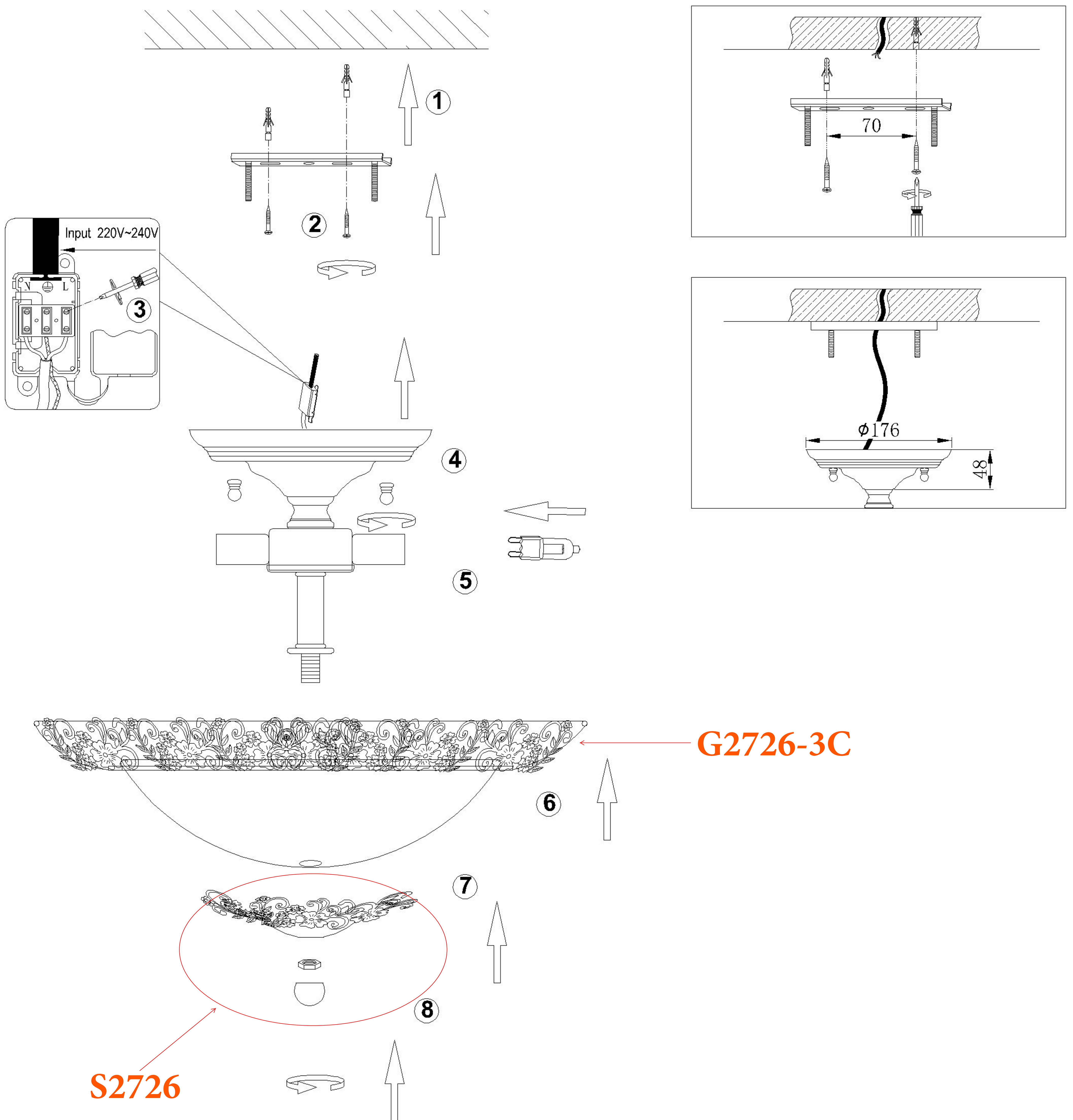

1

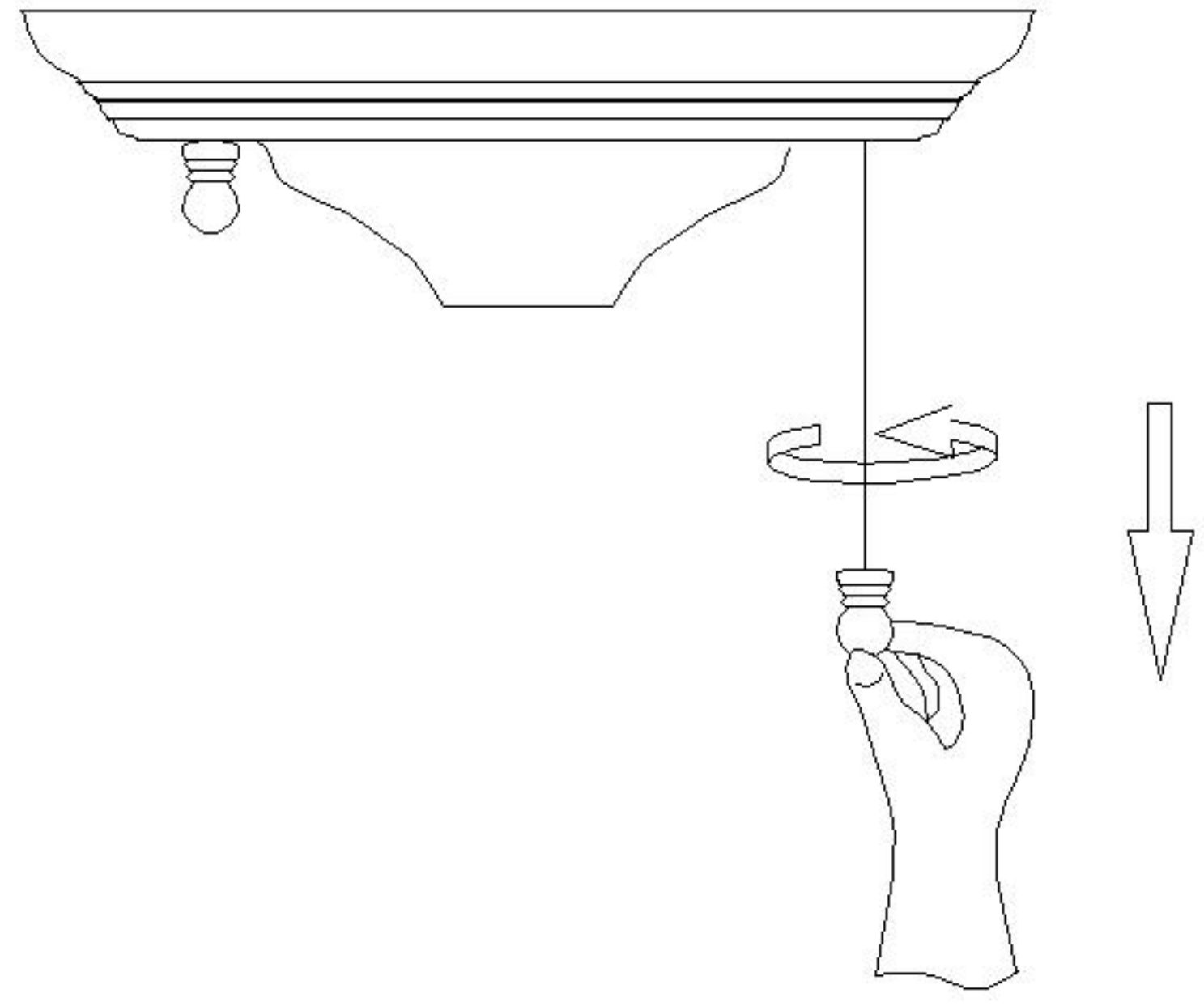

2

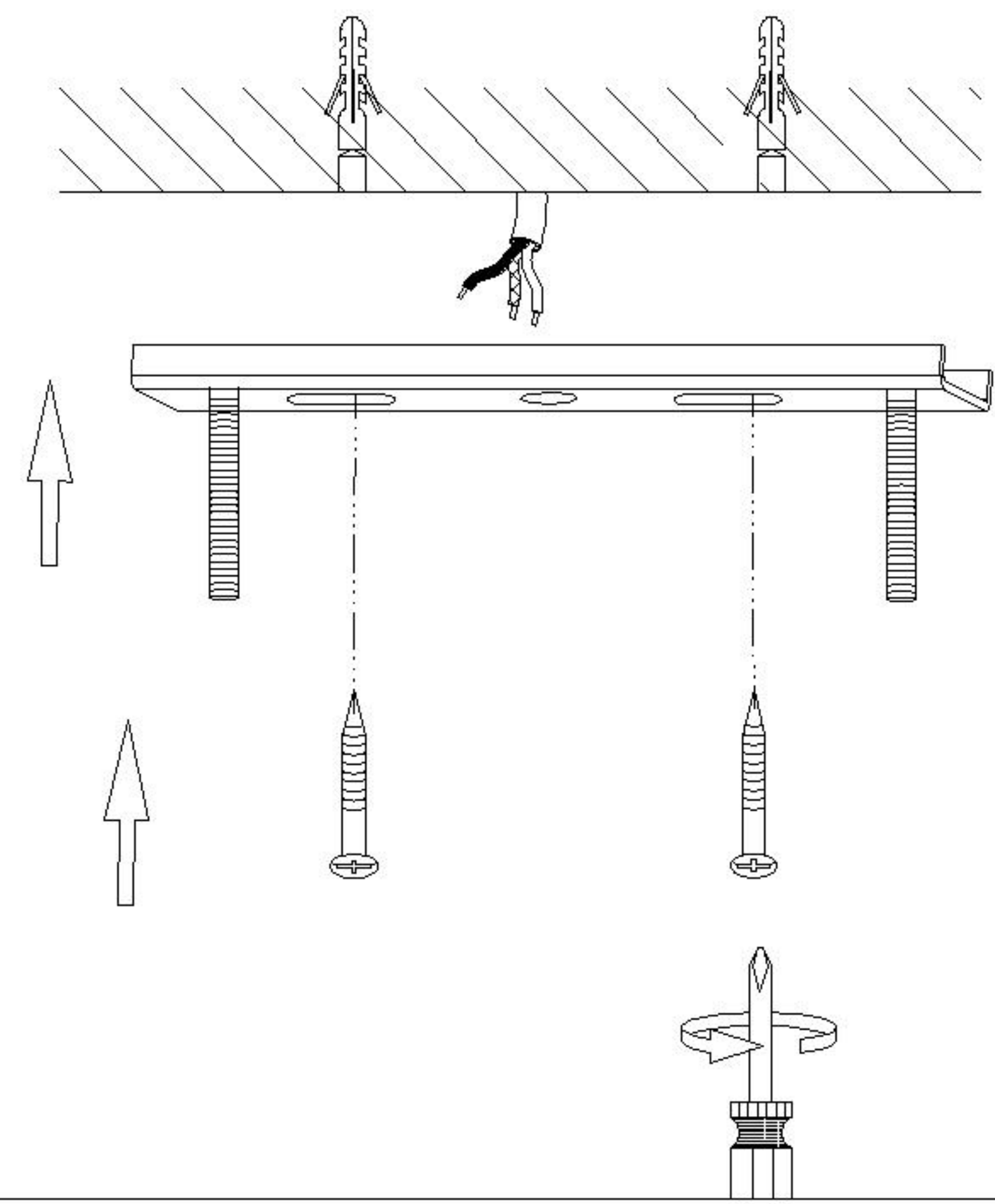

3

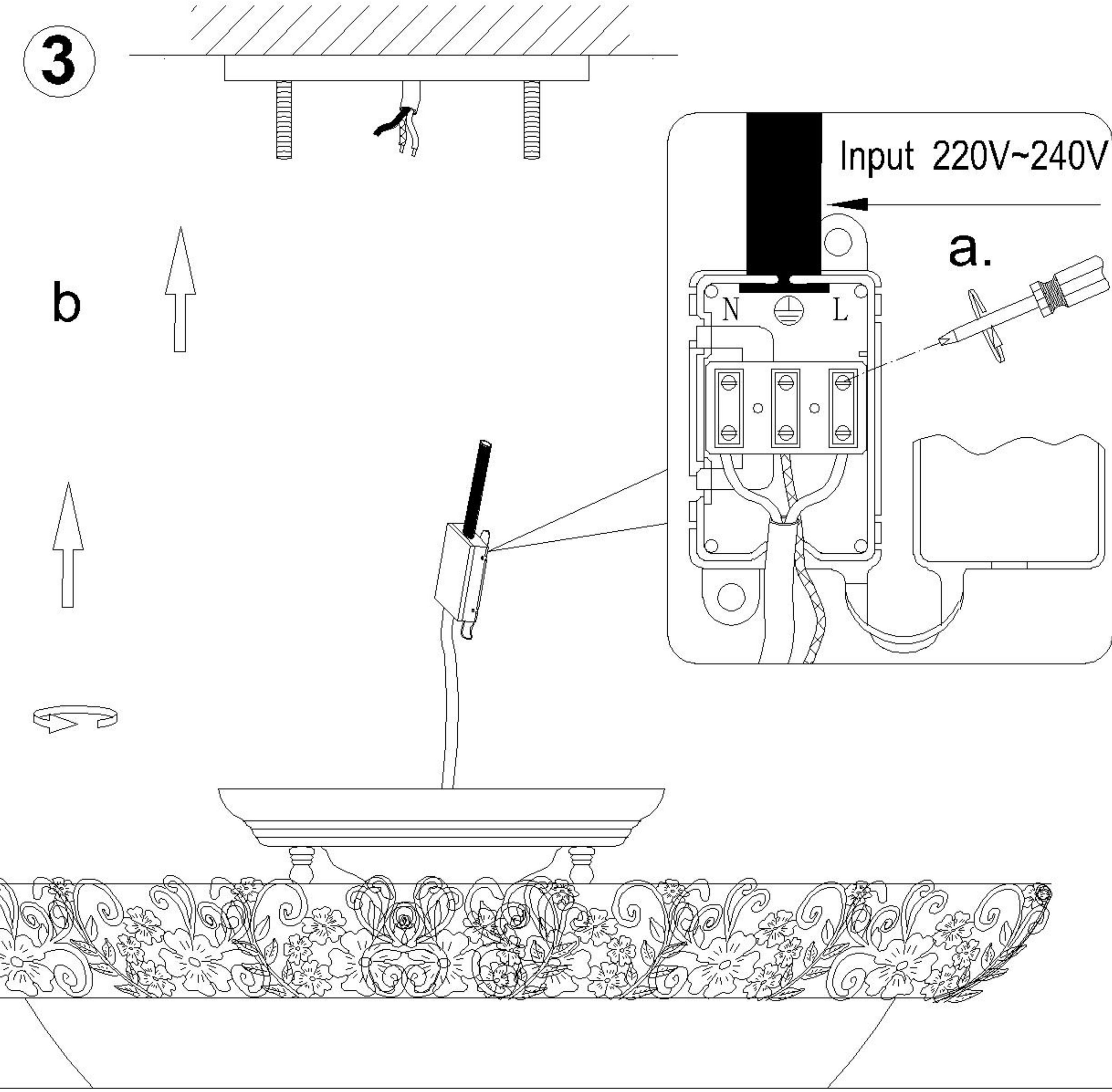

4

