

INSTALLATION INSTRUCTION ODEON LIGHT ART. 2685/1T

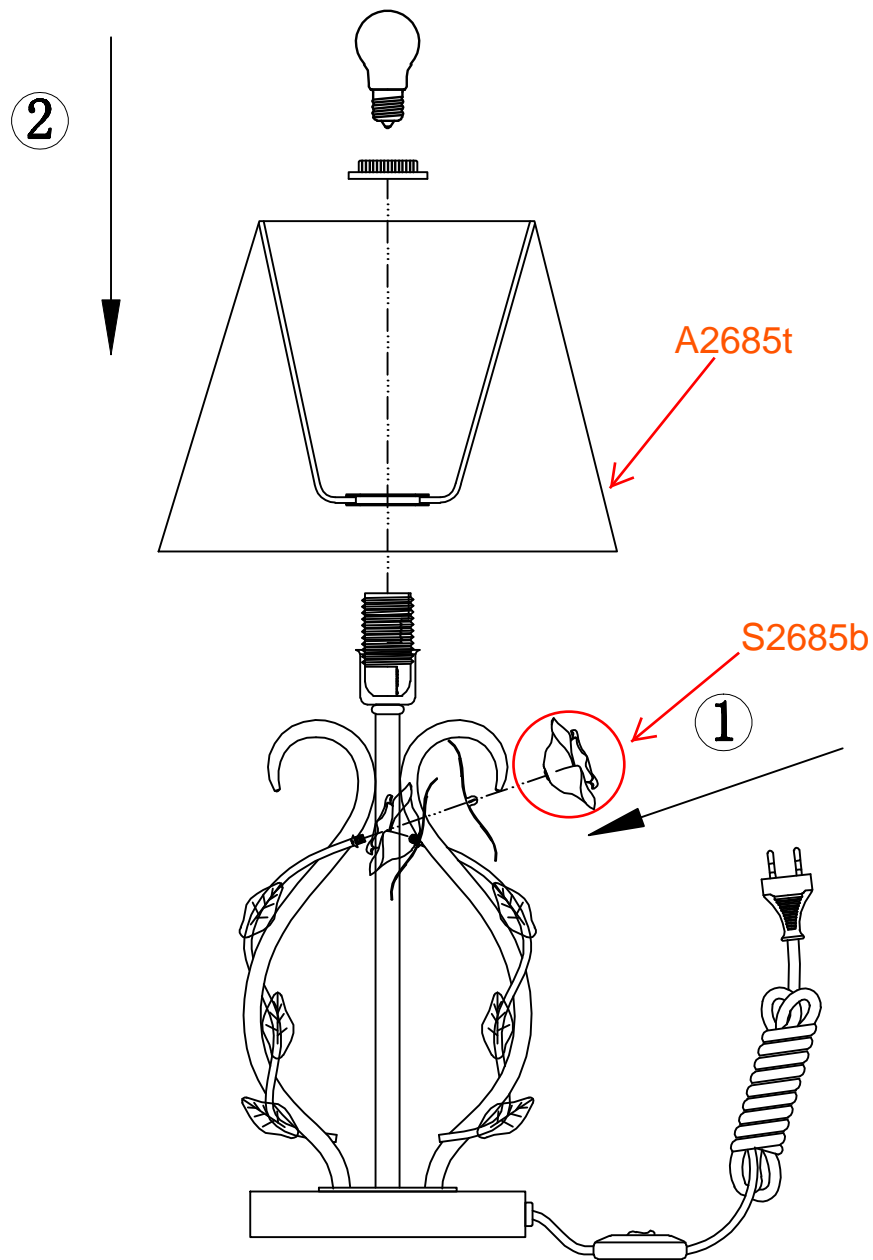

CAUTIONS FOR USE

1. Rated voltage is 220V-240V.
2. Wearing the gloves to avoid breaking the surface of the lamps and the wire while installing the lamps.
3. The lamp should be kept away from chemicals or gas which contain acid or alkalinity, do not clean it with water, only with soft cloth is advisable.
4. Installation should be carried out by electrician, power should be cut off before cleanliness or changing bulb.
5. If the external flexible cable or cord of this luminaire is damaged, it shall be replaced exclusively by the manufacturer or his agent or by a similar qualified person in order to avoid a hazard.