

INSTALLATION INSTRUCTION ODEON LIGHT ART. 2680/1W

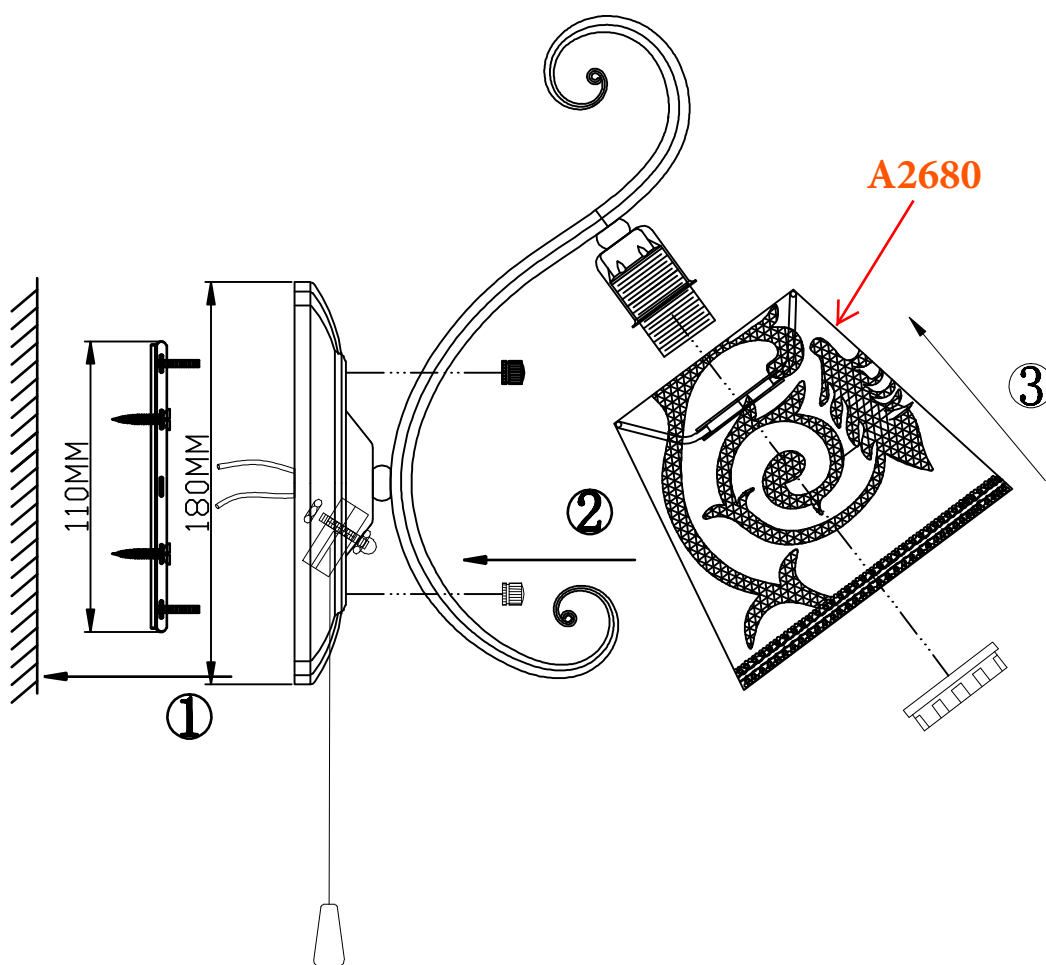

CAUTIONS FOR USE

1. Rated voltage is 220V-240V.
2. Wearing the gloves to avoid breaking the surface of the lamps and the wire while installing the lamps.
3. Connect the red wire to the anode of the lamps, the mixed color wire to the cathode and the "earth" printed wire to earth wire.
4. Please do not fix the lamp onto the damp ceiling, keep the surrounding ventilation and dry.
5. The lamp should be kept away from chemicals or gas which contain acid or alkalinity, do not clean it with water, only with soft cloth is advisable.
6. Installation should be carried out by electrician, power should be cut off before cleanliness or changing bulb.