

ODEON LIGHT INSTALLATION INSTRUCTION

Item No.:2608/4C

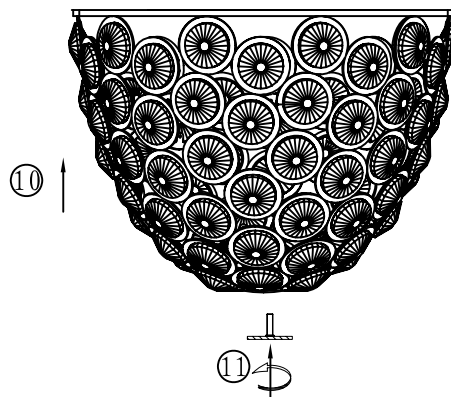
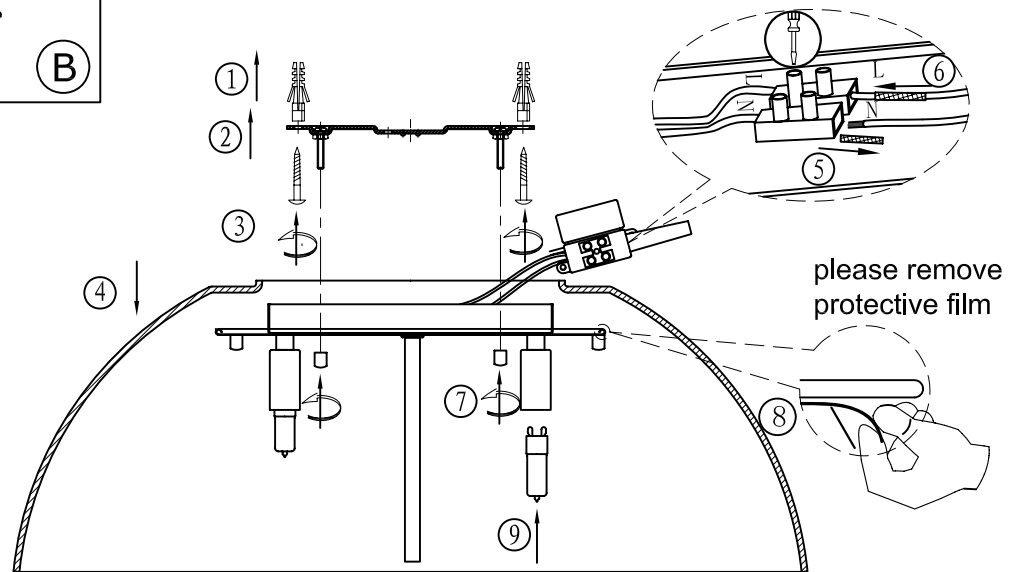
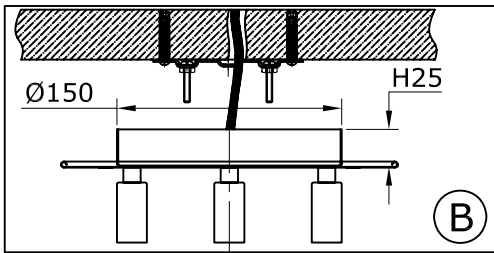
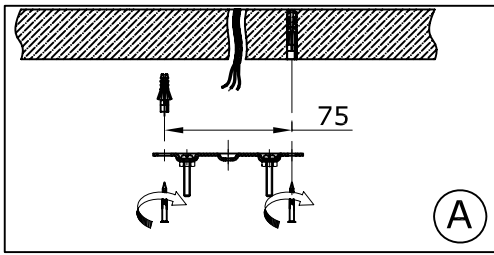

FEATURE

- 220-240V~50Hz
 - Lamp Type:G9 4×MAX 42W
- The lamp can be only indoor used

If in doubt,consult a qualified electrician or contact your retail outlet. Ensure that you always install the fitting to the relevant regulations.Certain regulations indicate that lighting fittings should be installed by a qualified electrician.