

# INSTALLATION INSTRUCTION

## ART:2475/2W ODEON LIGHT

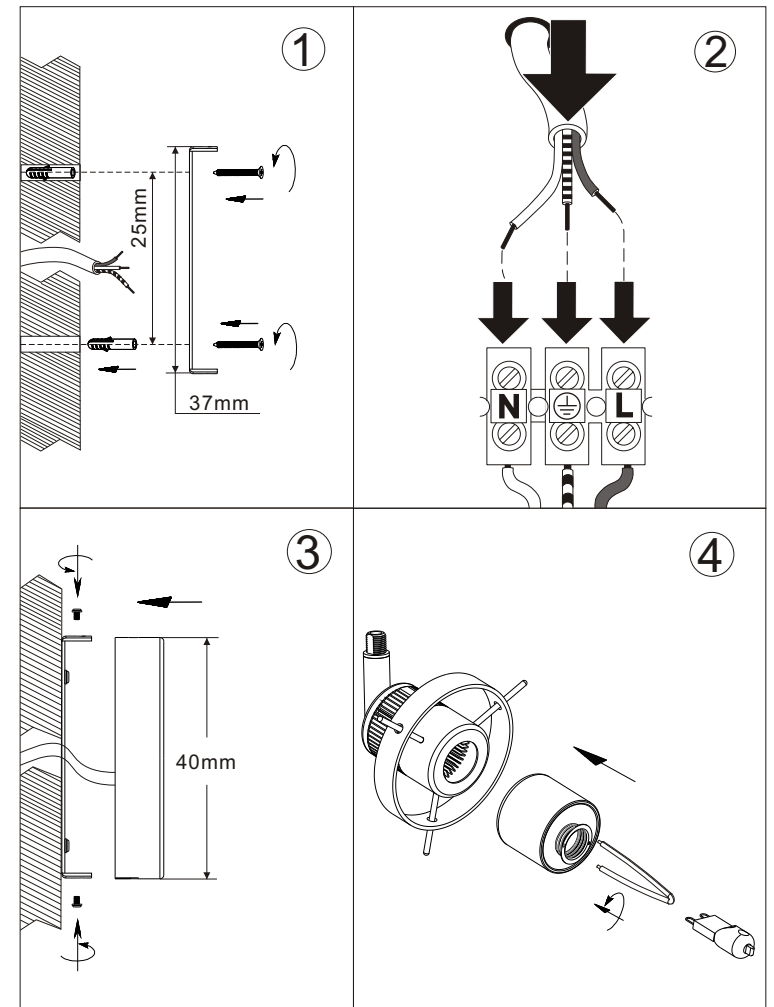
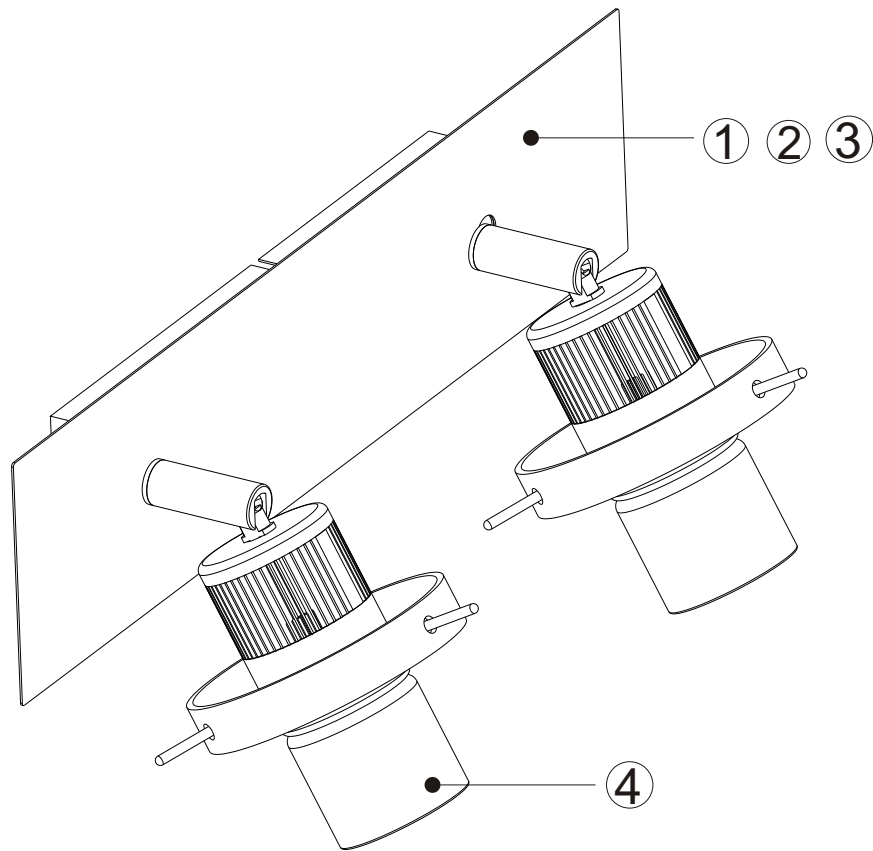

230V~50Hz G9 Max 2x40W