

INSTALLATION INSTRUCTION

ODEON LIGHT art.2421/1A

220V-240V ~50Hz
E27 1xMax.60W+1x1W LED

1

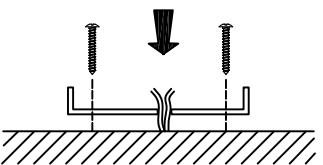

2

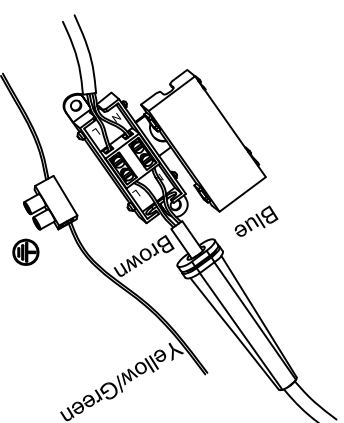

3

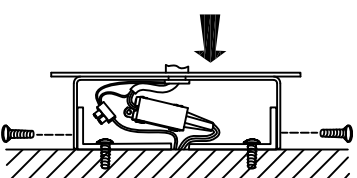

4

