

1

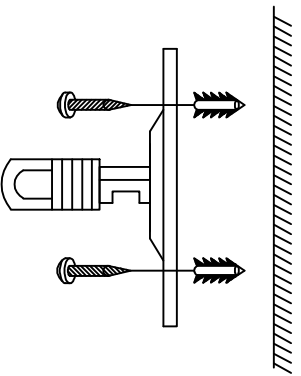

4

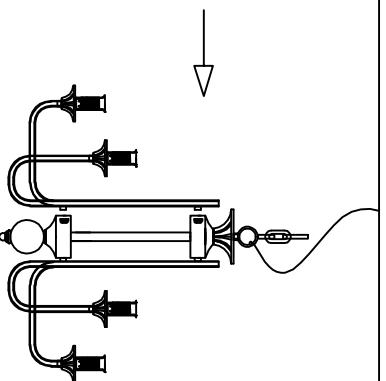

2

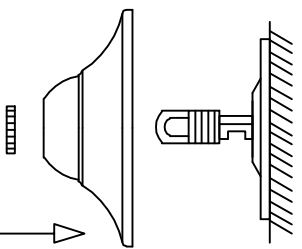

5

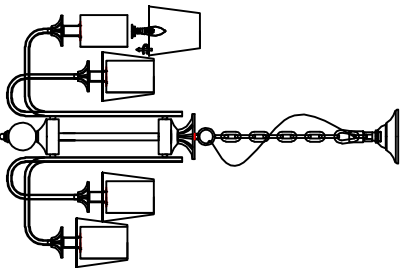

3

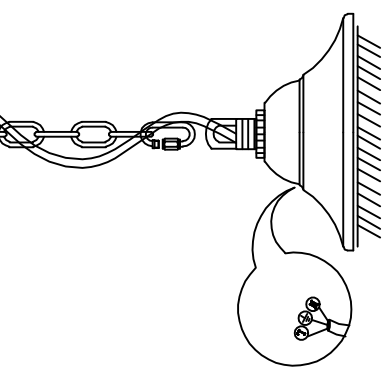

6

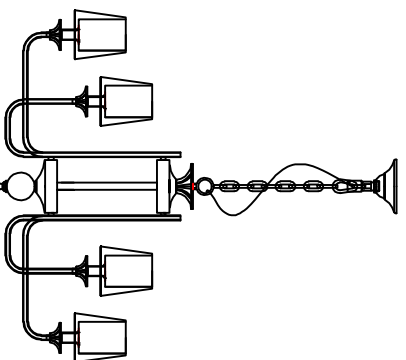

MODEL: 46010+5/C

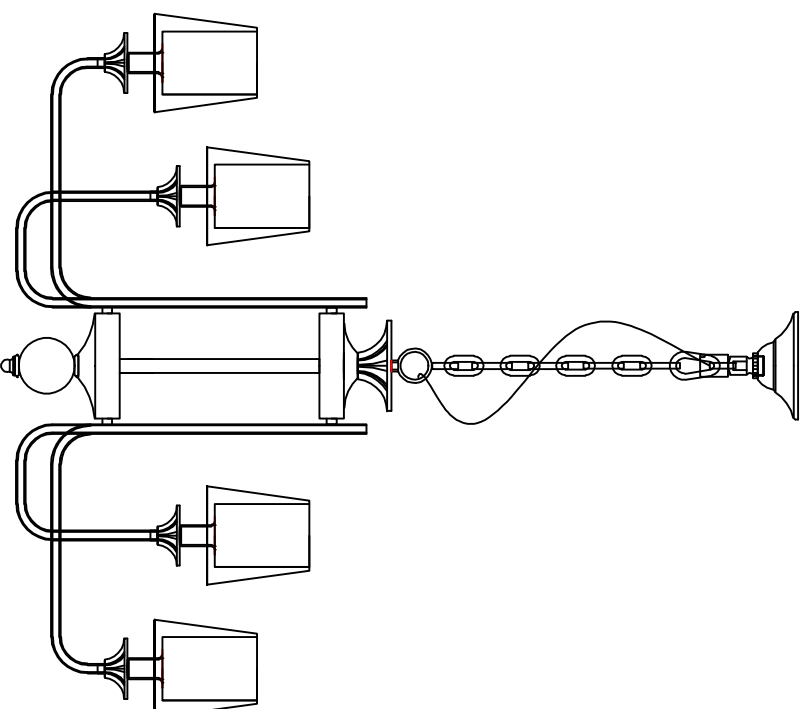

Safety precautions:

1. The power do not exceed the prescribed range (rated voltage AC220-240V 50Hz).
2. Please cut off the power supply while replacing the light source and other maintenance operation .
3. The plate fixed on the ceiling must be able to withstand the weight more than 3 times of the object.
4. After installation is complete, check the glass right or not? If it is damaged, it should be replaced immediately.

