

MODEL: 4202/T

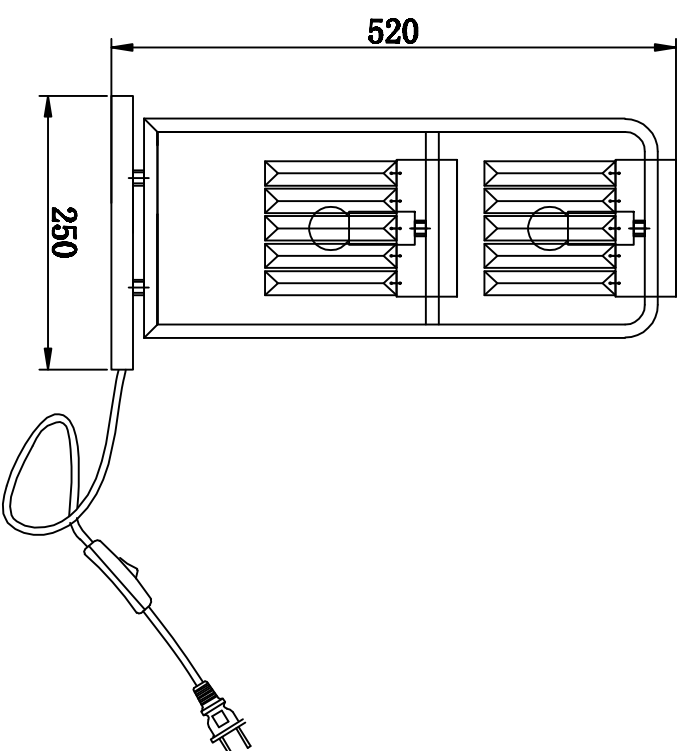

Safety precautions:

1. The power do not exceed the prescribed range (rated voltage AC220-240V 50Hz).
2. Please cut off the power supply while replacing the light source and other maintenance operation.
3. The plate fixed on the ceiling must be able to withstand the weight more than 3 times of the object.
4. After installation is complete, check the glass tight or not? If it is damaged, it should be replaced immediately.

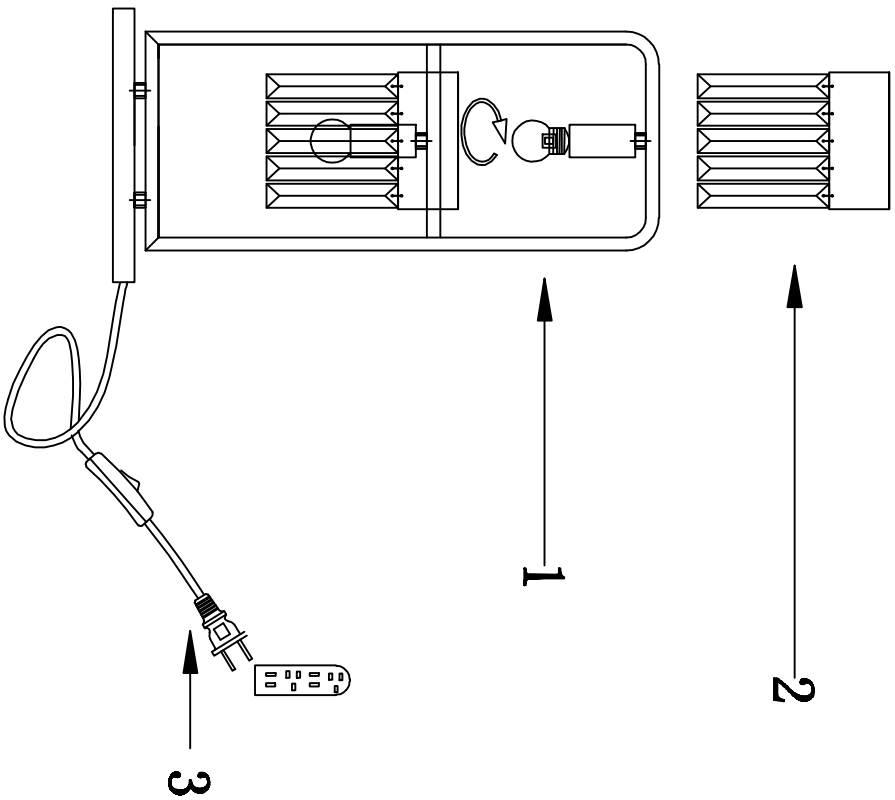