

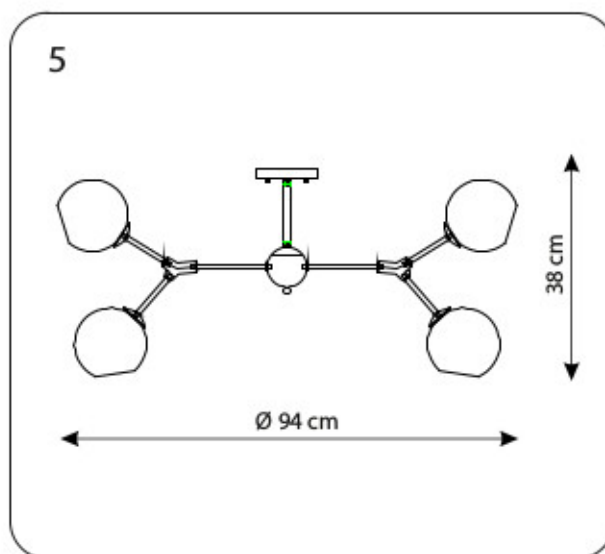

**ИНСТРУКЦИЯ ПО УСТАНОВКЕ И
ПОДКЛЮЧЕНИЮ СВЕТИЛЬНИКА**

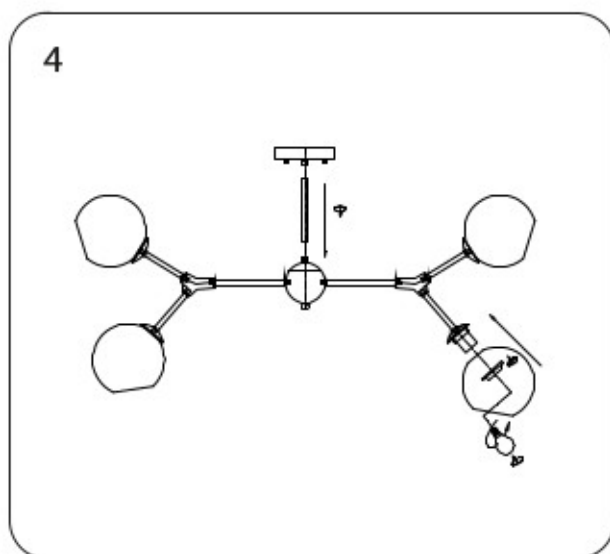

785063

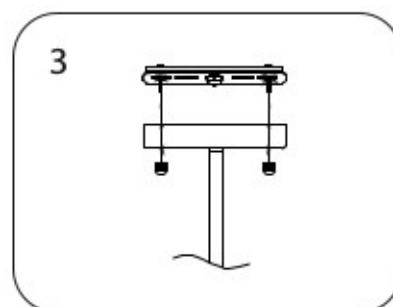
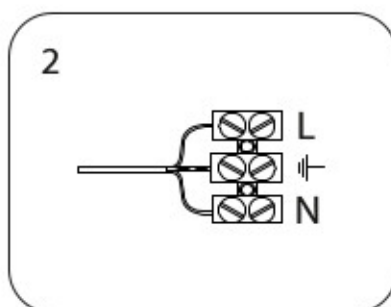
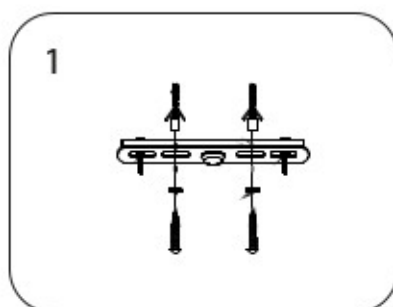

785066



785067

