

## WV 2 Black Edition

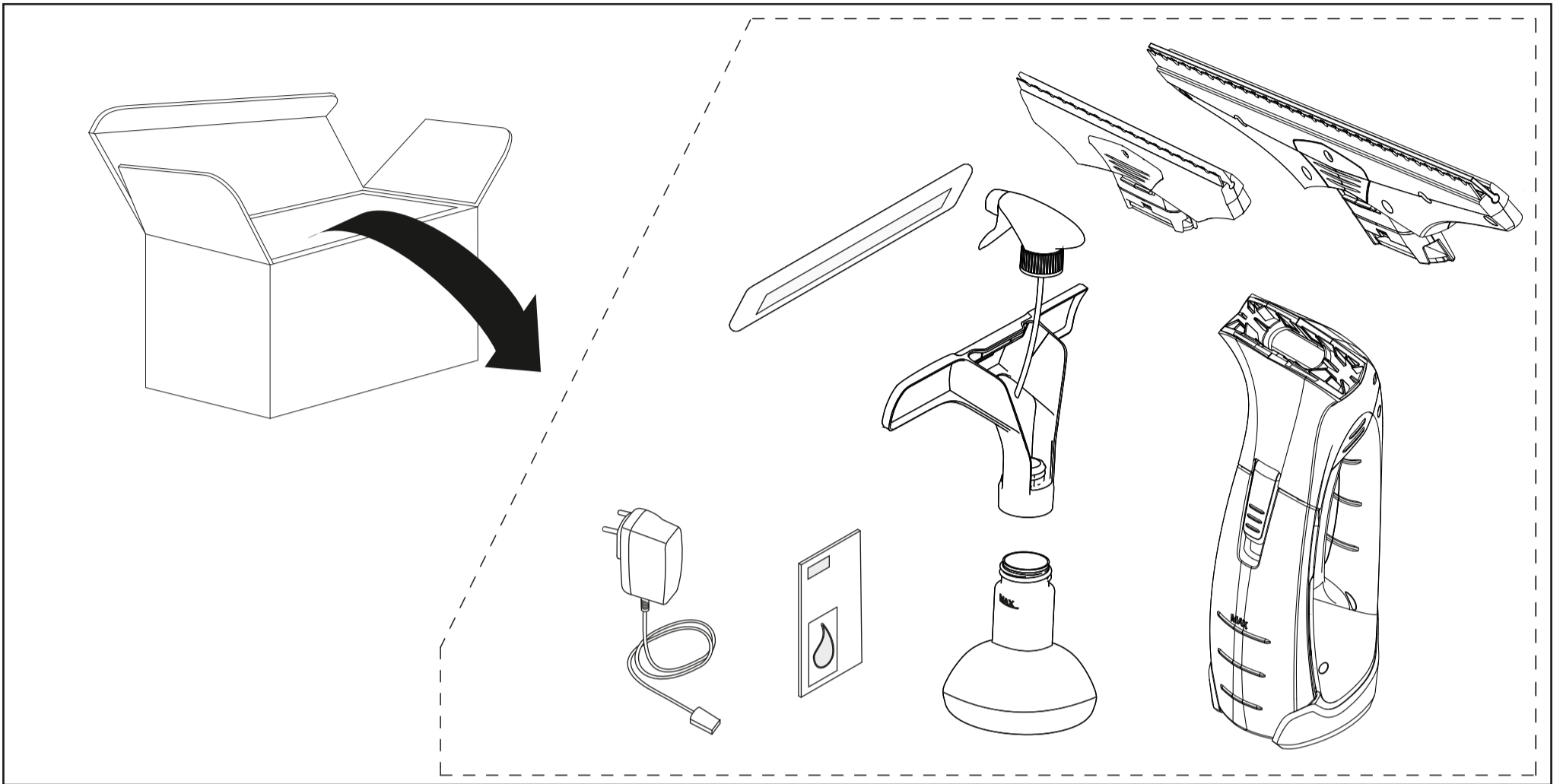

<p>Li-Ion</p>	<p>3,6 V</p> <p>3,7 V</p>		<p>IPX4</p>		<p>0,6 kg</p>
<p>nom</p>	<p>10 W</p>		<p>100 ml</p>		<p>185 min</p>
	<p>5,5 V</p> <p>600 mA</p>		<p>50 db(A)</p>		<p>35 min</p>

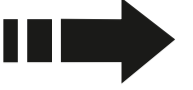
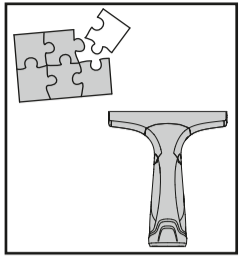

**1**

**2**

**3**

**4**

**5**

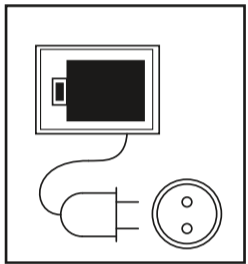

**1**

**2**

**3**

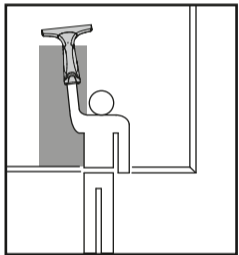

**1**

**2**

**3**

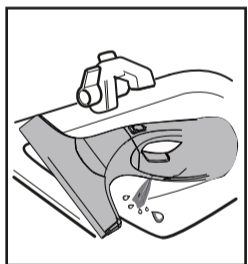

**1**

**2**

**3**

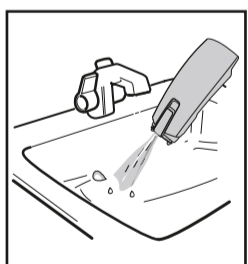

**1**

**2**

**3**

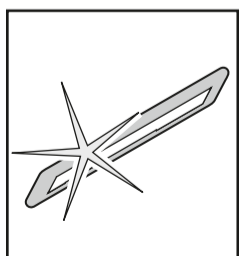

**1**

**2**

