

9498P/L850

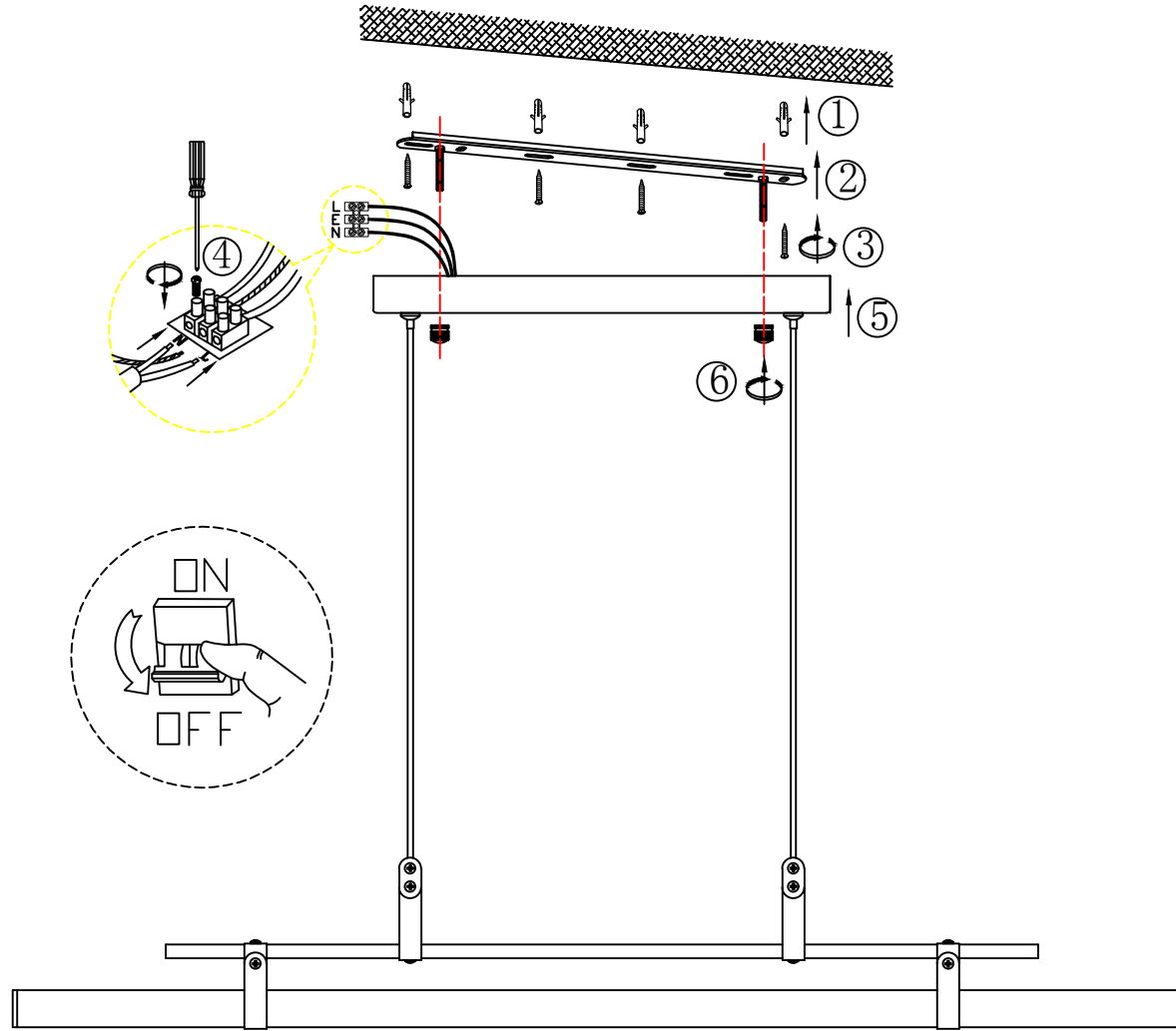

1. Rated Voltage: AC220~240V
2. Frequency: 50~60Hz
3. light source: LED
4. Material: Metal