

ENGLISH

Specification of installation

In order to ensure safety use, please notice the following items:

Read and understand the whole Specification.

Suitable for the use of 220~240V and 50~60Hz.

Please wear gloves as installment and avoid rot on the surface of plating.

Must be installed on the fixed places and be checked annually.

Please turn off the lighting source by soft cloth as cleaning prohibited to use of rotted detergent.

Please connect with the local sales service center when there are any abnormality.

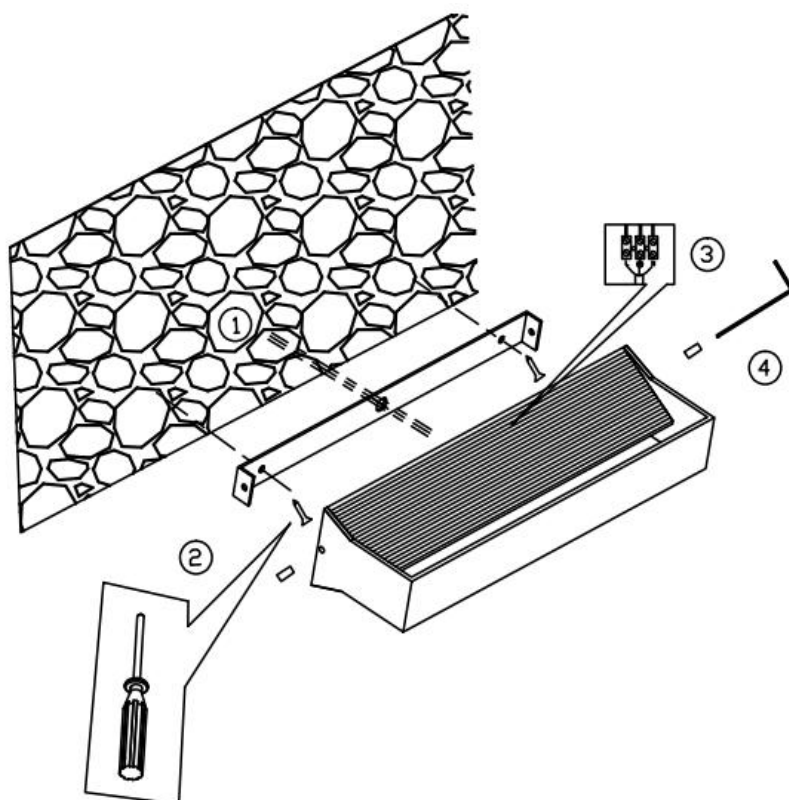

1. perforate on the wall
2. fix the lamp base to the wall
3. connect power flow
4. fix the lamp body to the lamp base
set screws on the lamp body

ART. CLT 326W530
IP20

FIXTURE SIZE:

